

Panasonic

Operating Instructions

5.8 GHz Digital Cordless
Answering System

Model No. **KX-TG5931AL**

5.8 GHz Expandable Digital Cordless
Answering System with Two Handsets

Model No. **KX-TG5932AL**

5.8 GHz Expandable Digital Cordless
Answering System with Three Handsets

Model No. **KX-TG5933AL**

5.8 GHz Digital Cordless
Answering System with Four Handsets

Model No. **KX-TG5934AL**

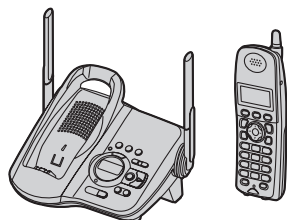

Model shown is KX-TG5931AL.

This unit is compatible with Caller ID. To use this feature, you must subscribe to the appropriate service offered by your service provider.

Charge the handset battery for 7 hours before initial use.

Please read these Operating Instructions before using the unit and save for future reference.

Table of Contents

Introduction

Introduction	3
About these operating instructions	4
Accessory information	7
Important safety instructions	9
For best performance	11

Preparation

Setting up the base unit	13
Setting up the handset	14
Controls	17
Displays	19
Setting the unit before use	20

Making/Answering Calls

Making calls	21
Answering calls	22
Useful features during a call	22

Phonebook

Handset phonebook	25
Copying handset phonebook items	27

Caller ID Service

Using Caller ID service	28
Caller list	30

Programming

Programmable settings	32
-----------------------	----

Answering System

Answering system	36
Listening to messages using the base unit	37
Listening to messages using the handset	38
Remote operation	39
Answering system settings	40

Multi-unit Operation

Intercom	42
----------	----

Transferring calls between handsets, conference calls	43
Registering a handset	44

Useful Information

Wall mounting	45
Headset (optional)	48
Error messages	49
Troubleshooting	50
Instructions to customer	54
Specifications	56

Index

Index	57
-------	----

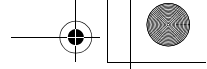

Introduction

Introduction

Thank you for purchasing a Panasonic cordless telephone.

We recommend keeping a record of the following information for future reference.

Serial No. _____ Date of purchase _____
(found on the bottom of the base unit)

Name and address of dealer _____

Attach your purchase receipt here.

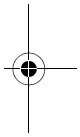
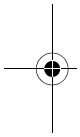

Introduction

About these operating instructions

These operating instructions can be used for KX-TG5931/KX-TG5932/KX-TG5933/
KX-TG5934.

Descriptions of the multiple handsets and chargers

The following models include 2 or more handsets and a charger(s). Descriptions of the multiple handsets and chargers in these operating instructions are for the following models only:

KX-TG5932



KX-TG5933



KX-TG5934



Introduction

Symbols used in these operating instructions

Symbol	Meaning
Example: "Ringer ID"	Press [▲] or [▼] to select the words in quotations shown on the display.
→	Proceed to the next operation.
Example: [MENU] , [Phonebook]	The words in the brackets indicate button names including soft key names (page 19) on the handset and base unit.
Example: [MENU] → [0][5][2] → Select the desired setting. → [Save] → [OFF]	Press [MENU] , then press [0] , [5] , [2] . Press [▲] or [▼] to select the desired setting. Press [Save] , then press [OFF] .

Introduction

Expanding your phone system

KX-TG5932/KX-TG5933 users can expand the system by adding accessory handsets sold separately (max. 4 handsets).

KX-TG5932

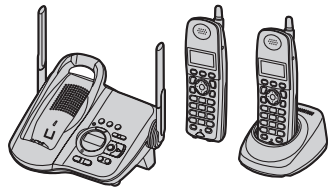

+

Accessory handset (up to 2)
KX-TGA560AZ

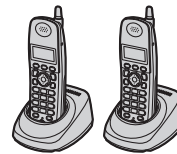

KX-TG5933

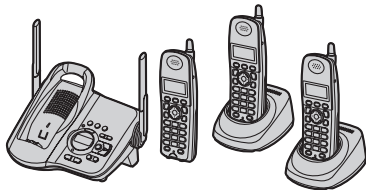

+

Accessory handset (up to 1)
KX-TGA560AZ



Introduction

Accessory information

Included accessories

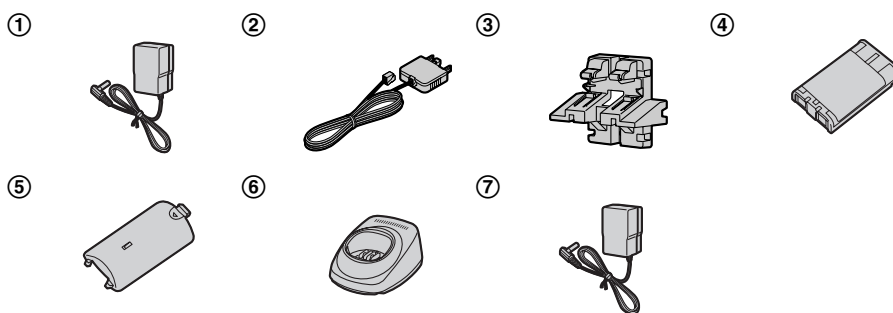

No.	Accessory item	Quantity			
		KX-TG5931	KX-TG5932	KX-TG5933	KX-TG5934
①	AC adaptor for base unit	1	1	1	1
②	Telephone line cord	1	1	1	1
③	Wall mounting adaptor	1	1	1	1
④	Battery	1	2	3	4
⑤	Handset cover ^{*1}	1	2	3	4
⑥	Charger	—	1	2	3
⑦	AC adaptor for charger	—	1	2	3

*1 The handset cover comes attached to the handset.

Introduction

Additional/replacement accessories

Accessory item	Order number
Rechargeable nickel metal hydride (Ni-MH) battery	HHR-P104
Accessory handset with charger ^{*1}	KX-TGA560AZ
Headset	KX-TCA86AL or KX-TCA92AL

*1 KX-TG5932/KX-TG5933 only

Accessory item	KX-TG5931	KX-TG5932/KX-TG5933/ KX-TG5934
Belt clip	PQKE10396Z1	PQKE10396Z2

Introduction

Important safety instructions

When using the product, basic safety precautions should always be followed to reduce the risk of fire, electric shock, or personal injury.

1. Read all instructions carefully.
2. Follow all warnings and instructions marked on the product.
3. Unplug the product from power outlets before cleaning. Do not use liquid or aerosol cleaners. Use a moist cloth for cleaning.
4. Do not use the product near water, for example near a bathtub, wash bowl, kitchen sink, etc.
5. Place the product securely on a stable surface. Serious damage and/or injury may result if the product falls.
6. Do not cover slots and openings on the product. They are provided for ventilation and protection against overheating. Never place the product near radiators, or in a place where proper ventilation is not provided.
7. Use only the power source marked on the product. If you are not sure of the type of power supplied to your home, consult your dealer or local power company.
8. Do not place objects on the power cord. Install the product where no one can step or trip on the cord.
9. Do not overload power outlets and extension cords. This can result in the risk of fire or electric shock.
10. Never push any objects through slots in the product. This may result in the

risk of fire or electric shock. Never spill any liquid on the product.

11. To reduce the risk of electric shock, do not disassemble the product. Take the product to an authorised service centre when service is required. Opening or removing covers may expose you to dangerous voltages or other risks. Incorrect reassembly can cause electric shock when the product is subsequently used.
12. Unplug the product from power outlets and take to an authorised service centre when the following conditions occur:
 - A. When the power cord is damaged or frayed.
 - B. If liquid has been spilled into the product.
 - C. If the product has been exposed to rain or water.
 - D. If the product does not work normally by following the operating instructions. Adjust only controls covered by the operating instructions. Improper adjustment may require extensive work by an authorised service centre.
 - E. If the product has been dropped or physically damaged.
 - F. If the product exhibits a distinct change in performance.
13. During thunderstorms, avoid using telephones including cordless phones. There is a risk of an electric shock from lightning.
14. Do not use the product to report a gas leak, when in the vicinity of the leak.

SAVE THESE INSTRUCTIONS

Introduction

CAUTION:

Installation

- Never install telephone wiring during a lightning storm.
- Never install telephone jacks in wet locations unless the jack is specifically designed for wet locations.
- Never touch uninsulated telephone wires or terminals unless the telephone line has been disconnected at the network interface.
- Use caution when installing or modifying telephone lines.
- Do not touch the plug with wet hands.
- The AC adaptor is used as the main disconnect device. Ensure that the AC outlet is installed near the product and is easily accessible.

Battery

To reduce the risk of fire or injury to persons, read and follow these instructions.

- Use only the battery(ies) specified.
- Do not dispose of the battery(ies) in a fire. They may explode. Check with local waste management codes for special disposal instructions.
- Do not open or mutilate the battery(ies). Released electrolyte is corrosive and may cause burns or injury to the eyes or skin. The electrolyte may be toxic if swallowed.
- Exercise care when handling the battery(ies). Do not allow conductive materials such as rings, bracelets or keys to touch the battery(ies), otherwise a short circuit may cause the battery(ies) and/or the conductive material to overheat and cause burns.

- Charge the battery(ies) provided, or identified for use with the product only, in accordance with the instructions and limitations specified in this manual.

WARNING:

- To prevent the risk of fire or electrical shock, do not expose the product to rain or any type of moisture.
- Unplug the product from power outlets if it emits smoke, an abnormal smell, or makes an unusual noise. These conditions can cause fire or electric shock. Confirm that smoke has stopped emitting and contact an authorised service centre.

Medical

- Consult the manufacturer of any personal medical devices, such as pacemakers or hearing aids, to determine if they are adequately shielded from external RF (radio frequency) energy. (The product operates in the frequency range of 5.76 GHz to 5.84 GHz, and the power output is 200 mW (max.)) Do not use the product in health care facilities if any regulations posted in the area instruct you not to do so. Hospitals or health care facilities may be using equipment that could be sensitive to external RF energy.

Notice

- Please ensure that a separate telephone, not dependent on local power, is available for emergency use.
- This equipment will be inoperable when mains power fails.

Introduction

- When a failure occurs which results in the internal parts becoming accessible, disconnect the power supply cord immediately and return the product to an authorised service centre.
- To minimise the possibility of lightning damage, when you know that a thunderstorm is coming, we recommend that you:
 - Unplug the telephone line cord from the phone socket.
 - Unplug the AC adaptor from the AC power outlet.
- No “000” or other calls can be made from this device during a mains power failure.
- The earpiece on the handset is magnetised and may retain small metallic objects.
- This equipment has been tested and found to comply with AS/NZS 3548: 1995 limits for electromagnetic interference. Any modifications to any part of the system or to any peripherals may void the EMC compliance of the system or the peripherals.

For best performance

Base unit location/avoiding noise

The base unit and other compatible Panasonic units use radio waves to communicate with each other. For maximum distance and noise-free operation, we recommend the following:

- Placing the product away from electrical appliances.
- Placing the base unit in a HIGH and CENTRAL location with no obstructions such as walls.
- Raising the antennas vertically.
- If you use the handset near a microwave oven which is being used, noise may be heard. Move away from the microwave oven and closer to the base unit.
- If you use the handset near another cordless phone’s base unit, noise may be heard. Move away from the other cordless phone’s base unit and closer to your base unit.

Environment

- Keep the product away from electrical noise generating devices, such as fluorescent lamps and motors.
- The product should be kept free from excessive smoke, dust, high temperature, and vibration.
- The product should not be exposed to direct sunlight.
- Do not place heavy objects on top of the product.
- When you leave the product unused for a long period of time, unplug the product from the power outlet.

Introduction

- The product should be kept away from heat sources such as heaters, kitchen stoves, etc. It should not be placed in rooms where the temperature is less than 5 °C or greater than 40 °C. Damp basements should also be avoided.
- The maximum calling distance may be shortened when the product is used in the following places: Near obstacles such as hills, tunnels, underground, near metal objects such as wire fences, etc.
- Operating near 5.8 GHz electrical appliances may cause interference. Move away from the electrical appliances.

Routine care

- Wipe the outer surface of the product with a soft moist cloth. Do not use benzine, thinner, or any abrasive powder.

Preparation

Setting up the base unit

Connecting the AC adaptor and telephone line cord

Connect the telephone line cord until it clicks into the base unit (❶) and telephone line socket (❷). Connect the AC adaptor cord by pressing the plug firmly (❸).

- Use only the included Panasonic AC adaptor PQLV1AL.

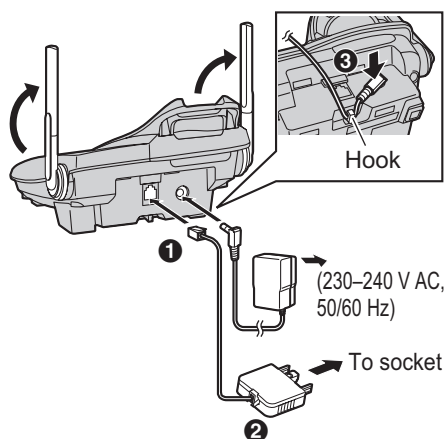

Note:

- The AC adaptor must remain connected at all times. (It is normal for the adaptor to feel warm during use.)
- The AC adaptor should be connected to a vertically oriented or floor-mounted AC outlet. Do not connect the AC adaptor to a ceiling-mounted AC outlet, as the weight of the adaptor may cause it to become disconnected.
- The unit will not work during a power failure. We recommend connecting a

standard telephone to the same telephone line or to the same telephone jack using a telephone double adaptor.

- The unit is not designed to be used with rotary (pulse dialling) services.

If you subscribe to an ADSL service

Please attach a noise filter (contact your ADSL provider) to the telephone line between the base unit and the telephone line socket in the event of the following:

- Noise is heard during conversations.
- Caller ID features (page 28) do not function properly.

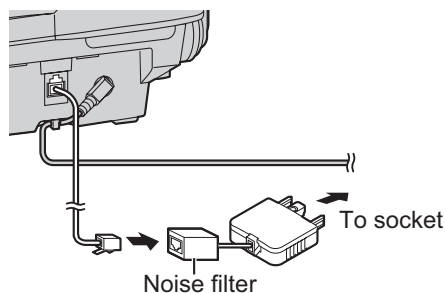

Preparation

Setting up the handset

Connecting the charger

Available model(s):
KX-TG5932/KX-TG5933/KX-TG5934

- Use only the included Panasonic AC adaptor KX-TCA1AL.

(230–240 V AC,
50/60 Hz)

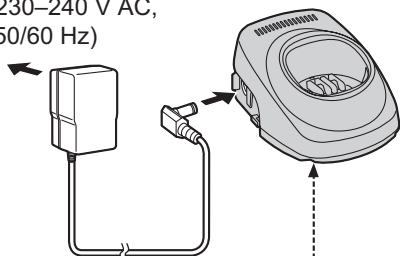

Bottom of the charger

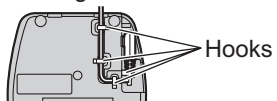

Fasten the AC adaptor cord to prevent it from being disconnected.

Battery installation/replacement

- 1 Press the notch of the handset cover firmly, and slide it in the direction of the arrow.
 - If necessary, remove the old battery.

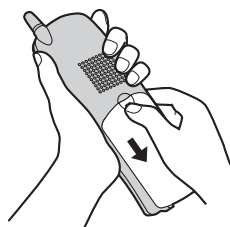

- 2 Insert the battery (1), and press it down until it snaps into position (2). Then close the handset cover.

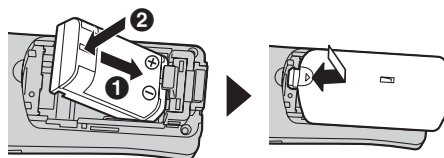

Important:

- Use only the rechargeable Panasonic battery noted on page 8.

Preparation

Battery charge

Place the handset on the base unit or charger for **7 hours** before initial use. While charging, "Charging" is displayed and the CHARGE indicator on the base unit lights. When the battery is fully charged, "Charge completed" is displayed.

Base unit:

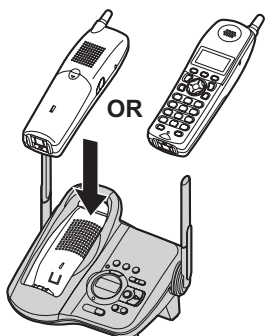

- Model shown is KX-TG5931.

Charger:

Available model(s):
KX-TG5932/KX-TG5933/KX-TG5934

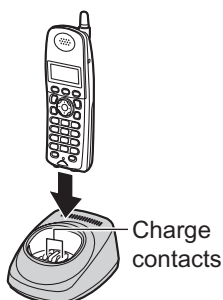

Note:

- If you want to use the unit immediately, charge the battery for at least 15 minutes.
- To ensure that the battery charges properly, clean the charge contacts of the handset, base unit, and charger with a soft, dry cloth once a month. Clean more often if the unit is subject to the exposure of grease, dust, or high humidity.

Battery level

Battery icon	Battery level
	Fully charged
	Medium
	Low Flashing: needs to be recharged.
	Empty

Note:

- When the battery needs to be charged, the handset beeps intermittently while it is in use.

Panasonic battery performance

Operation	Operating time
While in use (talking)	Up to 5 hours
While not in use (standby)	Up to 11 days
While using the clarity booster feature (page 23)	Up to 3 hours

Preparation

Note:

- Battery operating time may be shortened over time depending on usage conditions and surrounding temperature.
- Battery power is consumed whenever the handset is off the base unit or charger, even when the handset is not in use. Hence the longer you leave the handset off the base unit or charger, the less time you may actually talk using the handset.
- After the handset is fully charged, displaying “**Charge completed**”, it may be left on the base unit (or charger) without any ill effect on the battery.
- The battery level may not be displayed correctly after you replace the battery. In this case, place the handset on the base unit (or charger) and let charge for 7 hours.

Preparation

Controls

Base unit

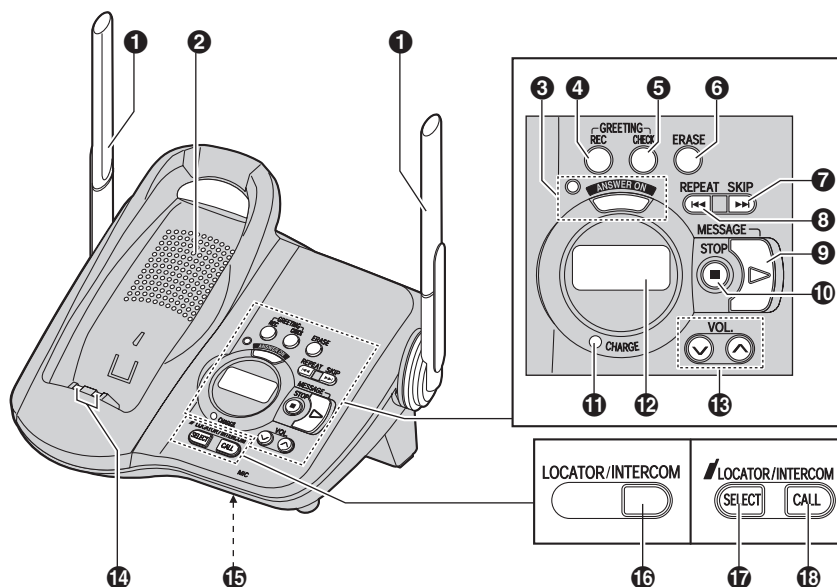

- | | |
|--------------------------------------|------------------------------------|
| ① Antennas | ⑩ [STOP] |
| ② Speaker | ⑪ CHARGE indicator |
| ③ [ANSWER ON]
ANSWER ON indicator | ⑫ Display |
| ④ [GREETING REC] (Recording) | ⑬ VOL. (Volume) [V] [^] |
| ⑤ [GREETING CHECK] | ⑭ Charge contacts |
| ⑥ [ERASE] | ⑮ MIC (Microphone) |
| ⑦ [▶▶] (SKIP) | ⑯ [LOCATOR/INTERCOM]* ¹ |
| ⑧ [◀◀] (REPEAT) | ⑰ [SELECT]* ² |
| ⑨ [MESSAGE]
MESSAGE indicator | ⑱ [CALL]* ² |

*1 KX-TG5931

*2 KX-TG5932/KX-TG5933/KX-TG5934

Preparation

Handset

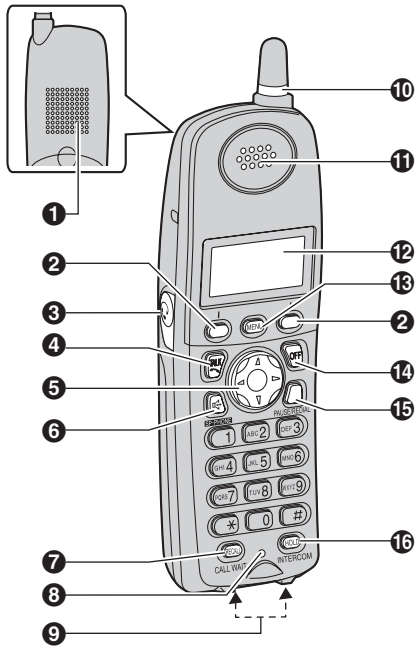

- ❶ Speaker
- ❷ Soft keys
- ❸ Headset jack
- ❹ [↩] (TALK)
- ❺ Navigator key ([▲] [▼] [◀] [▶])
- ❻ [☎] (SP-PHONE)
- ❼ [RECALL] [CALL WAIT]
- ❽ Microphone
- ❾ Charge contacts
- ❿ Ringer indicator
Message indicator
- ⓫ Receiver
- ⓬ Display
- ⓭ [MENU]
- ⓮ [OFF]
- ⓯ [PAUSE/REDIAL]
- ⓰ [HOLD] [INTERCOM]

- ⓮ [OFF]
- ⓯ [PAUSE/REDIAL]
- ⓰ [HOLD] [INTERCOM]

Note:

- Some operations not mentioned above are displayed as soft key selections during operation (page 19).

Example: [Mute]

Using the navigator key

The handset navigator key can be used to navigate through menus and to select items shown on the display, by pressing [▲], [▼], [◀], or [▶].

Adjusting audio volume

Press [▲] or [▼] repeatedly while talking.

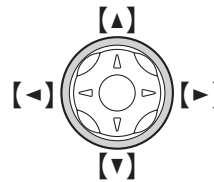

Preparation

Handset soft keys

The handset features 2 soft keys. By pressing a soft key, you can select the feature shown directly above it on the display.

[Select], **[Save]**, **[OK]** and additional other functions are assigned to soft keys, pay attention to soft keys to find functions you need during handset operation.

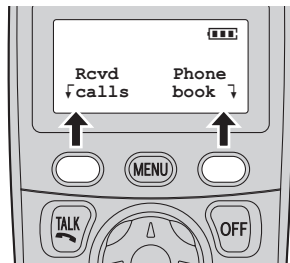

Note:

- In these operating instructions, soft key names are written inside brackets, the same way as other unit keys.

Example:

Unit keys: **[]**, **[OFF]**, etc.
Soft keys: **[Rcvd calls]**, **[Phonebook]**, etc.

Displays

Base unit display items

Displayed item	Meaning
FULL	Flashes when message memory is full.
	Flashes when the date and time need to be set.
IN USE	Base unit is on an intercom call, or handset is using the answering system. When flashing: base unit is paging or is being paged.
LINE IN USE	The line is in use. When flashing: the call is put on hold or the answering system is answering a call. When flashing rapidly: a call is being received.
RINGER OFF	Base unit ringer is off.
	Greeting message recording error
	Answering system is in greeting only mode (caller messages are not recorded).
H I	Handset number; displayed when paging, being paged or registering.*1

*1 KX-TG5932/KX-TG5933/KX-TG5934

Preparation

Handset display items

Displayed item	Meaning
ⓂⓋⓂ	Voice enhancer is on.
▢▢▢	Battery level

Setting the unit before use

Date and time

Set the correct date and time. When you play back a message from the answering system (page 37), the unit announces the day and time it was recorded.

- 1** [MENU] → [4]
- 2** Enter the current day, month, and year by selecting 2 digits for each.
Example: 15 August, 2006
 [1][5] [0][8] [0][6]
- 3** Enter the current hour and minute (12-hour clock format) by selecting 2 digits for each.
Example: 9:30
 [0][9] [3][0]
- 4** Press [AM/PM] to select "AM" or "PM".
 → [Save] → [OFF]

Note:

- If you make a mistake when entering the date and time, press [◀], [▶], [▲], or [▼] to move the cursor, then make the correction.
- If a power failure occurs, Ⓟ flashes to indicate the date and time must be set again.

Making/Answering Calls

Making calls

- 1 Lift the handset and dial the phone number.
 - To correct a digit, press **[Clear]**.
- 2 Press **[↶]** or **[Call]**.
- 3 When you finish talking, press **[OFF]** or place the handset on the base unit or charger.

Note:

- "Line in use" is displayed when someone is talking on another handset (KX-TG5932/KX-TG5933/KX-TG5934) or another phone.

Using the speakerphone

- 1 Lift the handset, dial the phone number, and press **[☎]**.
 - Speak alternately with the other party.
- 2 When you finish talking, press **[OFF]**.

Note:

- Use the speakerphone in a quiet environment.
- To switch to the receiver, press **[↶]**.

Adjusting the receiver/speaker volume

Press **[▲]** or **[▼]** repeatedly while talking.

Making a call using the redial list

The last 5 phone numbers dialed are stored in the redial list.

- 1 **[REDIAL]**
- 2 Press **[▲]** or **[▼]** to select the desired number.
- 3 **[↶]**

Erasing a number in the redial list

- 1 **[REDIAL]**
- 2 Press **[▲]** or **[▼]** to select the desired number. → **[Erase]** → **[Yes]** → **[OFF]**

PAUSE button (for PBX/long distance service users)

A pause is sometimes required when making calls using a PBX or long distance service.

For example, if you need to dial the line access number "9" when making outside calls with a PBX:

- 1 **[9]** → **[PAUSE]** → Dial the phone number.
- 2 **[↶]**







Note:

- A 3.5 second pause is inserted each time **[PAUSE]** is pressed. Press repeatedly to insert longer pauses.

Making/Answering Calls

Answering calls

When a call is being received, the ringer indicator flashes rapidly.

- 1 Lift the handset and press **[]** or **[]**.
 - You can also answer the call by pressing any button except **[]**, **[]**, **[]**, **[]**, or **[OFF]**. (**Any key talk feature**)
- 2 When you finish talking, press **[OFF]**.

Note:

- You can change the ringer indicator light colour and the ringer tone. You can also adjust the handset ringer volume (page 35).



Auto talk

This feature allows you to answer a call by simply lifting the handset off the base unit or charger. You do not need to press **[]**. To activate this feature, see page 34.

Temporary ringer off

While the handset is ringing for an outside call, you can turn the ringer off temporarily by pressing **[OFF]**.

Adjusting the base unit ringer volume

Press **[]** or **[]** repeatedly to select the desired volume.

- To turn the ringer off, press and hold **[]** until the unit beeps 2 times.

Useful features during a call

HOLD button

This feature allows you to put an outside call on hold.

KX-TG5931



Press **[HOLD]** during an outside call.

- To release the hold, press **[]**.

Note:

- If another phone is connected on the same line (page 13), you can also take the call by lifting its handset.
- If a call is kept on hold for more than 6 minutes, an alarm tone starts to sound. After 4 additional minutes on hold, the call is disconnected.

KX-TG5932/KX-TG5933/KX-TG5934

- 1 Press **[HOLD]** during an outside call.
 - To transfer the call to another handset, continue from step 2 on page 43, "Transferring calls between handsets, conference calls".
- 2 Press **[HOLD]** again.
 - To release the hold, press **[]**.
 - Another handset user can take the call by pressing **[]**.

Note:

- If another phone is connected on the same line (page 13), you can also take the call by lifting its handset.
- If a call is kept on hold for more than 6 minutes, an alarm tone starts to sound.

Making/Answering Calls

After 4 additional minutes on hold, the call is disconnected.

Mute

While mute is turned on, you can hear the other party, but the other party cannot hear you.

To mute your voice, press **[Mute]**.

- To return to the conversation, press **[Mute]** or **[↶]**.

Note:

- **[Mute]** is a soft key visible on the handset display during a call.

RECALL button

Pressing **[RECALL]** allows you to use special features of your host PBX such as transferring an extension call, or accessing optional telephone services such as Call Waiting.

Note:

- To change the recall time, see page 35.

Handset clarity booster

This feature can improve sound clarity when the handset is used in an area where there may be interference. During an outside call, this feature is turned on automatically when necessary. You can also turn this feature on or off manually.

1 Press **[MENU]** during an outside call.

2 Press **[2]** to select "Booster on" or "Booster off".

Note:

- When this feature is turned off manually during a call, it is not turned on automatically during the same call.

- While this feature is turned on;
 - the battery operating time is shortened (page 15).
 - the maximum number of extensions that can be used at a time may decrease when you have 3 or more handsets.

Handset voice enhancer

This feature can simulate a band signal above the normal bandwidth limitations, achieving a sound which is close to the actual voice. You can turn this feature on or off, depending on the circumstance (page 35).

Press **[(VE)]** during an outside call to turn on or off this feature.

- When this feature is turned on, **[(VE)]** is displayed.

Note:

- **[(VE)]** is a soft key visible on the handset during an outside call.
- Depending on the condition and quality of your telephone line, this feature may emphasise existing line noise. If it becomes difficult to hear, turn this feature off.

Call share

Available model(s):

KX-TG5932/KX-TG5933/KX-TG5934

This feature allows the handset to join an existing outside call.

To join the conversation, press **[↶]** when the other handset is on an outside call.



Making/Answering Calls

Note:

- A maximum of 4 parties (including 1 outside party) can join a conversation using 3 extensions.

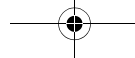

Phonebook

Handset phonebook

You can add up to 50 items to the handset phonebook and search for phonebook items by name.

Adding items to the phonebook

- 1 [Phonebook]**
- 2 [Add]**
- 3** Enter the name (max. 16 characters).
→ **[Next]**
- 4** Enter the phone number (max. 32 digits). → **[Next]** → **[Save]**
 - To add other items, repeat from step 2.

5 [OFF]

Note:

- Caller ID subscribers can use ringer ID and light-up ID features (page 29).

Character table

Key	Character
[1]	& ' () , - . / 1
[2]	a b c A B C 2
[3]	d e f D E F 3
[4]	g h i G H I 4
[5]	j k l J K L 5
[6]	m n o M N O 6
[7]	p q r s P Q R S 7
[8]	t u v T U V 8
[9]	w x y z W X Y Z 9

Key	Character
[0]	0 Space
[*]	*
[#]	#

- To enter another character that is located on the same dial key, first press **[▶]** to move the cursor to the next space.

Editing/correcting a mistake

Press **[◀]** or **[▶]** to move the cursor to the character or number you want to erase, then press **[Clear]**. Enter the appropriate character or number.

- Press and hold **[Clear]** to erase all characters or numbers.

Finding and calling a phonebook item

Phonebook items can be searched for alphabetically by scrolling through the phonebook items or by entering the first initial.

Searching for a name alphabetically by scrolling through all items

- 1 [Phonebook] → [Search]**
- 2** Press **[▲]** or **[▼]** to select the desired item.
- 3** Press **[↶]** to dial the phone number.

Phonebook

Searching for a name by initial

- 1 **[Phonebook]** → **[Search]**
- 2 Press the dial key (**[0]** – **[9]**, **[#]**, or **[*]**) that corresponds to the first letter you are searching for (see the character table, page 25).
Example: "LISA"
 Press **[5]** repeatedly to display the first phonebook entry starting with the initial "L" and go to step 3.
 - If there is no item corresponding to the letter you selected, the next item is displayed.
- 3 Press **[v]** to select the desired item.
- 4 Press **[↶]** to dial the phone number.

Editing items in the phonebook

- 1 Find the desired item (page 25, 26). → **[Option]** → "Edit" → **[Select]**
- 2 Edit the name if necessary (see the character table, page 25). → **[Next]**
- 3 Edit the phone number if necessary. → **[Next]** → **[Save]** → **[OFF]**

Erasing items in the phonebook

- 1 Find the desired item (page 25, 26).
- 2 **[Erase]** → **[Yes]** → **[OFF]**

Chain dial

This feature allows you to dial phone numbers in the handset phonebook while you are on a call. This feature can be used, for example, to dial a calling card access number or bank account PIN that you have stored in the handset phonebook, without having to dial manually.

- 1 During an outside call, press **[MENU]**.
- 2 "Phonebook" → **[Select]**
- 3 Find the desired item (page 25, 26). → **[Call]**

Note:

- When storing a calling card access number and your PIN in the phonebook as one phonebook item, press **[PAUSE]** to add pauses after the number and PIN as necessary (page 21).

Copying handset phonebook items

Available model(s):
KX-TG5932/KX-TG5933/KX-TG5934

You can copy one or all of the phonebook items from one handset to another.

Important:

- Ringer ID and light-up ID settings for phonebook items are not copied.

Copying an item

- 1** [MENU] → [≡][1]
- 2** Select the destination unit by pressing [▲] or [▼]. → [Next]
- 3** Press [▲] or [▼] to select the desired item. → [Send]
- 4** Press [OFF] after the long beep.

Copying all items

- 1** [MENU] → [≡][2]
- 2** Select the destination unit by pressing [▲] or [▼]. → [Send]
- 3** Press [OFF] after the long beep.

Caller ID Service

Using Caller ID service

This unit is Caller ID compatible. To use Caller ID features (such as displaying caller phone numbers), you must subscribe to Caller ID service. Consult your service provider/telephone company for details.

Caller ID features

When an outside call is being received, the calling party's telephone number is displayed.

Telephone numbers for the last 50 different callers are logged in the caller list by the most recent call to the oldest.

- If the unit cannot receive caller information, the following is displayed:
 - **“Out of area”**: The caller dialed from an area which does not provide Caller ID service.
 - **“Private caller”**: The caller requested not to send caller information.
- If the unit is connected to a PBX system, caller information may not be received properly. Consult your PBX supplier.
- If the name display service is available in your area, the display shows caller names. For further information, please contact your service provider/telephone company.

Missed calls

If a call is not answered, the unit treats the call as a missed call. The number of missed calls is shown on the handset display. This lets you know if you should view the caller list to see who called while you were out.

Phonebook name display

When caller information is received and it matches a phone number stored in the phonebook, the stored name is displayed and logged in the caller list.

Call waiting and Caller ID compatible

If you subscribe to Caller ID service, your handset displays the 2nd caller's information while talking. After you hear a call waiting tone, the caller's phone number will be displayed.

You can answer the 2nd call, keeping the 1st call on hold.

Follow your service provider/telephone company instructions using **[RECALL]**.

- If the phone number is stored in the phonebook with its name, the caller's name will also be displayed.
- Please contact your service provider/telephone company for details and availability in your area.

For Caller ID Type II users

When you receive a 2nd call during a conversation, you will hear a signal tone following the call waiting tone and the **conversation will be interrupted or muted for a short period of time**. This is not a fault of the product as these events are normal.

- The tones are generated by your service provider/telephone company.

Caller ID Service

Ringer ID

This feature can help you identify who is calling by using different ringers for different callers stored in the phonebook. You can assign a different ringer to each phonebook item. When a call is received from a caller stored in the phonebook, the ringer is used after Caller ID information is displayed.

If you select **"No Ringer ID"**, the handset uses the ringer tone you selected on page 35 when a call is received from that caller. The default setting is **"No Ringer ID"**.

- The ringer may be changed after the 2nd ring.

- 1** Find the desired item (page 25, 26). → **[Option]**
- 2** **"Ringer ID"** → **[Select]**
- 3** Select the desired ringer tone.
- 4** **[Save]** → **[OFF]**

Light-up ID

This feature can help you identify who is calling by using different ringer indicator colours for different callers stored in the handset phonebook. You can assign a different indicator colour to each handset phonebook item. When a call is received from a caller stored in the handset phonebook, the indicator colour is used after Caller ID information is displayed.

If you select **"No Light-up ID"**, the handset uses the ringer indicator colour you selected on page 34 when a call is received from that caller.

The default setting is **"No Light-up ID"**.

- The indicator colour may be changed after the 2nd ring.

- 1** Find the desired item (page 25, 26). → **[Option]**
- 2** **"Light-up ID"** → **[Select]**
- 3** Select the desired ringer indicator colour.
- 4** **[Save]** → **[OFF]**

Caller ID Service

Caller list

Viewing the caller list and calling back

- 1 Press [**▲**] or [**▼**] to enter the caller list.
- 2 Press [**▼**] to search from the most recent call, or [**▲**] to search from the oldest call.
- 3 [**↶**]

Note:

- If you do not want to dial the area codes when making calls from the Caller ID list, you can store the area codes which you want the unit to delete automatically (page 30).
- KX-TG5932/KX-TG5933/KX-TG5934: Each handset has its own caller list. If you viewed the caller list or answered a call on one handset, the same information in the other handsets is displayed as "missed calls".
- You can also press [**Rcvd calls**] to enter the caller list.
- If the same caller calls more than once, it is displayed with the number of times the caller called ("x2" to "x9"). Only the date and time of the most recent call is stored.
- A ✓ is displayed next to items which have already been viewed or answered.
- If an arrow (→) is displayed after the number, the whole phone number is not shown. Press [**▶**] to see the remaining numbers. To return to the previous display, press [**◀**].

Storing your area code

We recommend storing your area code before using Caller ID (page 28). Calls from the same area will be recorded in the caller list without the area code. You do not have to remove it before calling back the caller or storing in the phonebook.

- 1 [**MENU**] → [**0**][**4**]
- 2 Enter your area code (max. 8 digits).
 - To correct a digit, press [**◀**] or [**▶**] to move the cursor, then press [**Clear**]. Enter the correct number.
- 3 [**Save**] → [**OFF**]

To erase your area code

Press and hold [**Clear**] in step 2, press [**Save**], then press [**OFF**].

Editing a caller's phone number before calling back

You can edit a phone number in the caller list.

- 1 Press [**▲**] or [**▼**] to enter the caller list.
- 2 Select the desired item. → [**Select**] → [**Edit**]
- 3 Add or erase digits to the beginning of the number as necessary.
 - To add a digit, press the desired dial key.
 - To erase a digit, press [**Clear**] or [**#**].
- 4 [**↶**]

Note:

- The edited phone number is not saved in the caller list.

Storing caller information into the phonebook

- 1** Press [**▲**] or [**▼**] to enter the caller list.
- 2** Select the desired item. → [**Select**]
 - To edit the number, press [**Edit**], then edit the number (see step 3 on page 30, "Editing a caller's phone number before calling back").
- 3** [**Save**]
 - If there is the name information for the caller, skip to step 5.
- 4** Enter the name (see the character table, page 25). → [**Next**] → [**Save**]
- 5** [**OFF**]

Erasing selected caller information

- 1** Press [**▲**] or [**▼**] to enter the caller list.
- 2** Select the desired item.
- 3** [**Erase**] → [**Yes**] → [**OFF**]

Erasing all caller information

- 1** Press [**▲**] or [**▼**] to enter the caller list.
- 2** [**All erase**] → [**Yes**]

Programming

Programmable settings

You can customise the unit by programming the following features using the handset. To access the features, there are 2 methods: scrolling through the display menus (page 32) or using the direct commands (page 34).

- Mainly the direct command method is used in these operating instructions.

Programming by scrolling through the display menus

1 [MENU]

2 Press [▲] or [▼] to select the desired menu. → [Select]

- If there is a sub-menu(s), press [▲] or [▼] to select the desired item. → [Select]

Example: To access the handset ringer tone setting

Press [▲] or [▼] to select "Ringer setting". → [Select]

Then press [▲] or [▼] to select "Ringer tone". → [Select]

3 Press [▲] or [▼] to select the desired setting.

- This step may vary depending on the feature being programmed.

4 [Save] → [OFF]

Main menu	Sub-menu 1	Sub-menu 2	Page
Message play	–	–	page 38
Ringer setting	Ringer volume	–	–
	Ringer tone	–	–
	Ring colour	–	–
Date and time ^{*1}	–	–	page 20
Voice enhancer	–	–	–
Copy phonebook ^{*2}	Copy 1 item	–	page 27
	Copy all items	–	page 27

Programming

Main menu	Sub-menu 1	Sub-menu 2	Page
Initial setting	Set answering	Ring count ^{*1}	page 40
		Recording time ^{*1}	page 41
		Remote code ^{*1}	page 40
	Message alert	–	page 41
	LCD contrast	–	–
	Key tone	–	–
	Auto talk	–	–
	Set area code	–	page 30
	Time adjustment ^{*1}	–	–
	Set tel line	Set dial mode ^{*1}	–
		Set recall time ^{*1}	–
		Set line mode ^{*1}	–
	Set base unit	Ringer tone ^{*1}	–
	Registration	–	page 44

*1 If you programme these settings using one of the handsets, you do not need to programme the same item using another handset (KX-TG5932/KX-TG5933/KX-TG5934).

*2 KX-TG5932/KX-TG5933/KX-TG5934

Programming

Programming using the direct commands

1 [MENU]

2 Enter the desired feature code.

3 Enter the desired setting code.

- This step may vary depending on the feature being programmed.

4 [Save] → [OFF]

Note:

- In the following table:
 - < > shows the default setting.
 - If “System setting” column is checked, you do not need to programme the same item using another handset (KX-TG5932/KX-TG5933/KX-TG5934).
- If you make a mistake or enter the wrong code, press [OFF], then start again by pressing [MENU].

Feature	Feature code	Setting code	System setting
Auto talk ^{*1}	[0][3]	[1]: On [0]: <Off>	–
Copy phonebook (1 item) ^{*2}	[#][1]	(page 27)	–
Copy phonebook (all items) ^{*2}	[#][2]	(page 27)	–
Date and time	[4]	(page 20)	●
Key tone ^{*3}	[0][2]	[1]: <On> [0]: Off	–
LCD contrast (Display contrast)	[0][1]	[1]–[6]: Level 1–6 <3>	–
Message alert	[0][#]	[1]: On [0]: <Off>	–
Message play	[2]	–	–
Recording time	[0][6][2]	[1]: 1min [2]: 2min [3]: <3min> [0]: Greeting only	●
Registration	[0][0]	(page 44)	–
Remote code	[0][6][3]	(page 40)	●
Ring colour (Ringer indicator colour)	[1][4]	[1]: <Colour1>=Amber [2]: Colour2=Green [3]: Colour3=Red [4]: Multicolour	–
Ring count	[0][6][1]	[2]–[7]: 2–7 rings <4> [0]: Toll saver	●

Programming

Feature	Feature code	Setting code	System setting
Ringer tone (Base unit)	[0][*][1]	[1]–[3]: Tone <1>–3	–
Ringer tone (Handset)	[1][2]	[1]–[3]: Tone <1>–3 [4]–[7]: Melody 1–4	–
Ringer volume (Handset)	[1][1]	[1]: Low [2]: Medium [3]: <High> [0]: Off	–
Set area code	[0][4]	(page 30)	–
Set dial mode	[0][5][1]	(page 51)	●
Set line mode ^{*4}	[0][5][3]	[1]: A [2]: 	●
Set recall time ^{*5}	[0][5][2]	[1]: 700ms [2]: 600ms [3]: 400ms [4]: 300ms [5]: 250ms [6]: 110ms [7]: <100ms> [8]: 90ms	●
Time adjustment ^{*6} (Caller ID subscribers only)	[0][9]	[1]: <Caller ID[auto]> [0]: Manual	●
Voice enhancer	[5]	[1]: On [0]: <Off>	–

*1 If you subscribe to Caller ID service and want to view the caller's information after lifting up the handset to answer a call, turn off this feature.

*2 KX-TG5932/KX-TG5933/KX-TG5934

*3 You can select whether or not key tones are heard when keys are pressed. Includes confirmation tones and error tones.

*4 Generally, the line mode setting should not be adjusted. If "Line in use" is not displayed when another phone connected to the same line is in use, you need to change the line mode to "A".

*5 The recall time depends on your telephone exchange or host PBX. Consult your PBX supplier if necessary.

You can access your service provider/telephone company "Call Waiting" service by having the recall time set at 100 ms, and then follow your service provider/telephone company "Call Waiting" instructions to operate this service.

*6 This feature allows the unit to automatically adjust the date and time setting when caller information is received. To use this feature, set the date and time first.

Answering System

Answering system

Important:

- Only 1 person can access the answering system at a time.
- When callers leave messages, the unit records the day and time of each message. Make sure the date and time have been set (page 20).

Memory capacity

The total recording capacity (including your greeting message and caller messages) is about 15 minutes. A maximum of 64 messages (including a greeting message) can be recorded.

- If the message memory becomes full, the ANSWER ON indicator flashes rapidly (if the answering system is turned on). Erase unnecessary messages (page 37).
- If less than 3 minutes of recording time are available, the unit announces the remaining recording time when operating the answering system. Erase unnecessary messages (page 37).

Turning the answering system on/off

Press **[ANSWER ON]** to turn on/off the answering system.

- When the answering system is turned on, the ANSWER ON indicator lights.
- When the answering system is turned off, the ANSWER ON indicator turns off.

Screening calls

While a caller is leaving a message, you can listen to the call through the base unit's speaker. To adjust the speaker volume, press **[^]** or **[v]** repeatedly. You can answer the call by pressing **[hook]** on the handset.

Turning off the call screening feature

When the base unit is not in use, press **[GREETING CHECK]**, then press **[v]** repeatedly until "0" is displayed.

OR

While screening, press **[v]** repeatedly until "0" is displayed.

Note:

- If you adjust the speaker volume while listening to messages or talking on the intercom, the speaker volume for call screening is turned on again.

Recording your greeting message

You can record your own greeting message (max. 2 minutes) that is played when the answering system answers a call. If you do not record a greeting message, a prerecorded greeting message is used.

1 **[GREETING REC]**

2 Within 10 seconds, press **[GREETING REC]** again.

3 After the base unit beeps, speak clearly about 20 cm away from the MIC.

4 To stop recording, press **[STOP]**.

Answering System

Playing back the greeting message

Press **[GREETING CHECK]**.

Erasing your greeting message

Press **[GREETING CHECK]**, and then press **[ERASE]** while your greeting message is playing.

Prerecorded greeting message

If you erase or do not record your own greeting message, the unit plays a prerecorded greeting message for callers and ask them to leave messages. If the message recording time (page 41) is set to "Greeting only", caller messages are not recorded and the unit plays a different prerecorded greeting message asking callers to call again.

Listening to messages using the base unit

When new messages have been recorded, the MESSAGE indicator on the base unit flashes.

Press **[MESSAGE]**.

- The unit plays new messages.
- When you have no new messages, the unit plays back all messages.

Adjusting the speaker volume

Press **[^]** or **[v]** repeatedly while listening to a message.

Repeating a message

Press **[|<<]** during playback.

- If pressed within the first 5 seconds of a message, the previous message is played.

Skipping a message

Press **[>>|]** during playback.

Pausing a message

Press **[STOP]** during playback.

- To resume playback, press **[MESSAGE]**.
- To stop playback completely, press **[STOP]** again.

Erasing a message

Press **[ERASE]** during playback.

Erasing all messages

Press **[ERASE]** 2 times while the unit is not being used.

Answering System

Listening to messages using the handset

When new messages have been recorded:

- "New message" is displayed.
- The message indicator on the handset flashes slowly if the message alert feature is turned on (page 41).

1 [MENU]

2 "Message play" → [Select]

- The handset plays new messages.
- When you have no new messages, the handset plays back all messages.

3 Press [OFF] when finished.

Note:

- You can also listen to the messages by pressing [MENU], then pressing [2].
- To switch to the receiver, press [↶].

Adjusting the receiver/speaker volume

Press [▲] or [▼] repeatedly while listening to a message.

Voice guidance

If you do not press any buttons after the last message is played back, the unit's voice guidance starts. Operate the answering system by following the guidance as necessary.

Calling back (Caller ID subscribers only)

If Caller ID information was received for the call, you can call the caller back while listening to the message.

1 Press [Select] during playback.

- To edit the number before calling back, press [Edit] and edit the number (page 30).

2 [Call]

Answering system commands

You can also operate the answering system by pressing dial keys on the handset during playback.

Key	Command
[1] or [←]	Repeat message (during playback) ^{*1}
[2] or [→]	Skip message (during playback)
[4]	Play new messages
[5]	Play all messages
[8]	Turn answering system on
[9]	Stop playback ^{*2}
[0]	Turn answering system off
[*][4] or [Erase]	Erase currently playing message
[*][5]	Erase all messages

*1 If pressed within the first 5 seconds of a message, the previous message is played.

*2 To resume operation, press a command key within 15 seconds, or the voice guidance will start.

Answering System

Remote operation

Using a touch tone phone, you can call your phone number from outside and access the unit to listen to messages. The unit's voice guidance prompts you to press certain dial keys to perform different operations.

Important:

- In order to operate the answering system remotely, you must first set a remote code (page 40). This code must be entered each time you operate the answering system remotely.

Using the answering system remotely

- 1 Dial your phone number from a touch tone phone.
- 2 After the greeting message starts, enter your remote code (page 40).
 - The unit plays back new messages.
 - After playing back new messages, the voice guidance starts.
- 3 Follow the voice guidance as necessary.
- 4 When finished, hang up.

Note:

- You can ignore the voice guidance and control the unit using remote commands (page 39).

Voice guidance

During remote operation, the unit's voice guidance prompts you to press **[1]** to perform a specific operation, or press **[2]** to listen to more available operations.

Operations are presented by voice guidance in the following order:

- Play back all messages
- Play back new messages
- Record a message
- Erase all messages

Note:

- If you do not press any dial keys within 10 seconds after a voice guidance prompt, the unit disconnects your call.
- If less than 3 minutes of recording time is available, the unit announces the remaining recording time after the last message is played back.

Remote commands

You can press dial keys to access certain answering system functions without waiting for the voice guidance to prompt you.

Key	Remote command
[1]	Repeat message (during playback) ^{*1}
[2]	Skip message (during playback)
[4]	Play new messages
[5]	Play all messages
[9]	Stop playback ^{*2}
[0]	Turn answering system off

Answering System

Key	Remote command
[*][4]	Erase currently playing message
[*][5]	Erase all messages

*1 If pressed within the first 5 seconds of a message, the previous message is played.

*2 To resume operation, enter a remote command within 15 seconds, or the voice guidance starts.

Turning on the answering system remotely

If the answering system is off, you can turn it on remotely.

- 1 Dial your phone number.
- 2 Let the phone ring 15 times.
 - The unit answers your call with the greeting message.
 - You can hang up, or if you call from a touch tone phone, you can enter your remote code and begin remote operation (page 39).

Skipping the greeting message to leave a message

You can leave a message just as any outside caller can. Call your phone number. When the answering system picks up, press **[*]** to skip the greeting message and record your message after the beep.

Answering system settings

Remote code

A remote code must be entered when operating the answering system remotely. This code prevents unauthorised parties from listening to your messages remotely. The default setting is "11".

1 [MENU] → [0][6][3]

2 Enter the desired 2-digit remote code.
→ **[Save] → [OFF]**

Ring count

You can change the number of times the phone rings before the unit answers calls. The default setting is "4".

"**Toll saver**": The unit answers on the 2nd ring when new messages have been recorded, and on the 4th ring when there are no new messages. If you call your phone from outside to listen to new messages (page 39), you will know that there are no new messages when the phone rings for the 3rd time. You can then hang up without being charged for the call.

1 [MENU] → [0][6][1]

2 Select the desired setting. → **[Save] → [OFF]**

For Service Provider Voice Mail Subscribers

To receive Voice Mail and use answering system properly, please note the following:

Answering System

- “Voice Mail” is a service provided by your service provider/telephone company. You will need to first subscribe or activate this service through your service provider/telephone company. Consult your service provider/telephone company on how to operate this service and how you will be notified that you have messages on your Voice Mail. To use this service you will be required to leave your answering machine off on your unit. This will allow the Voice Mail to receive any messages. This unit does not have a visual indicator to indicate if there are new messages in your Voice Mail service. Your service provider/telephone company may use a “Stutter” dial tone (special dial tone) to indicate that there are new messages on your Voice Mail.
- To use the unit’s answering machine rather than the Voice Mail service provided by your service provider/telephone company, please consult your service provider/telephone company to have it removed or deactivated permanently or temporarily. Alternatively you can leave this service connected and change the “Ring count” to a shorter duration on your unit so your unit’s answering machine can pick up the call prior to the Voice Mail provided by your service provider/telephone company.

Note:

- Provider Voice Mail can capture messages that can be missed while the customer is on the Internet.

Caller’s recording time

You can change the maximum message recording time allotted to each caller.

The default setting is “3min”.

“Greeting only”: The unit plays the greeting message but does not record caller messages.

1 [MENU] → [0][6][2]

2 Select the desired setting. → **[Save]**
→ **[OFF]**

Note:

- If the message memory becomes full, the unit automatically switches to the “Greeting only” mode and no new messages are recorded. If you have recorded your own greeting message, that same greeting message is announced to callers even though their messages are not recorded. If you have not recorded your own greeting message, the prerecorded message used for “Greeting only” mode is announced to callers (page 37).

Message alert

You can select whether or not the message indicator on the handset flashes when new messages are recorded (page 38). The default setting is “OFF”.

1 [MENU] → [0][#]

2 Select the desired setting. → **[Save]**
→ **[OFF]**

Note:

- While message alert is on, battery operating time is shortened (page 15).

Multi-unit Operation

Intercom

Intercom calls can be made:

- between the handset and base unit
- between handsets (KX-TG5932/KX-TG5933/KX-TG5934)

Note:

- If you receive a phone call while talking on the intercom, you hear 2 tones. To answer the call, press **[OFF]**, then press **[↶]**.
- You can locate a misplaced handset by paging it (handset locator).

KX-TG5931

Making an intercom call

Handset

- 1 [INTERCOM]**
 - The base unit beeps for 1 minute.
- 2** To end the intercom call, press **[OFF]**.

Base unit

- 1 [LOCATOR/INTERCOM]**
 - The handset beeps for 1 minute.
- 2** To end the intercom call, press **[LOCATOR/INTERCOM]**.

Answering an intercom call

Handset

- 1** Press **[↶]** to answer the page.
- 2** To end the intercom call, press **[OFF]**.

Base unit

- 1** Press **[LOCATOR/INTERCOM]** to answer the page.
- 2** To end the intercom call, press **[LOCATOR/INTERCOM]**.

Note:

- When the ringer volume is set to off, the handset or the base unit rings at the low level for intercom calls.

KX-TG5932/KX-TG5933/KX-TG5934

Making an intercom call

Handset

- 1 [INTERCOM]**
- 2** To page the base unit, press **[0]**. To page another handset, enter its extension number (**[1] – [4]**).
 - The destination unit beeps for 1 minute.
- 3** To end the intercom call, press **[OFF]**.

Multi-unit Operation

Base unit

- 1 Press **[SELECT]** repeatedly to display the desired handset number. → **[CALL]**
 - The handset beeps for 1 minute.
- 2 To end the intercom call, press **[CALL]**.

Answering an intercom call

Handset

- 1 Press **[↶]** to answer the page.
- 2 To end the intercom call, press **[OFF]**.

Base unit

- 1 Press **[CALL]** to answer the page.
- 2 To end the intercom call, press **[CALL]**.

Note:

- When the ringer volume is set to off, the handset or the base unit rings at the low level for intercom calls.

Transferring calls between handsets, conference calls

Available model(s):

KX-TG5932/KX-TG5933/KX-TG5934

Outside calls can be transferred between 2 handsets. 2 handsets can have a conference call with an outside party.

- 1 During an outside call, press **[INTERCOM]** to put the call on hold.
- 2 To page another handset, enter its extension number (**[1]** – **[4]**).
 - **[4]** can be used if you have 4 handsets.
- 3 Wait for the paged party to answer.
 - If the paged party does not answer, press **[↶]** to return to the outside call.
- 4 To complete the transfer, press **[OFF]**.
 - The outside call is being routed to another handset.

To establish a conference call, press **[Conf]**.

 - To leave the conference, press **[OFF]**. The other parties can continue the conversation.
 - To put the outside call on hold, press **[HOLD]**. To resume the conference, press **[Conf]**.

Multi-unit Operation

Answering transferred calls

Press **[RECALL]** to answer the page.

- After the paging party disconnects, you can talk to the outside caller.

Registering a handset

The included handset and base unit are preregistered. If for some reason the handset is not registered to the base unit, register the handset.

KX-TG5931

- 1 Handset:**
[MENU] → [0][0]
- 2 Base unit:**
 Press and hold **[LOCATOR/INTERCOM]** until the CHARGE indicator flashes.
 - After the CHARGE indicator starts flashing, the rest of the procedure must be completed within 1 minute.
- 3 Handset:**
 Press **[OK]**, then wait until the handset beeps.

KX-TG5932/KX-TG5933/KX-TG5934

Important:

- If you accidentally assign another handset's extension number to the base unit, the originally assigned handset stops functioning. Confirm the extension number of the handset by placing it on the base unit or charger. Lift the handset from the charger before registering.

- 1 Handset:**
[MENU] → [0][0]
- 2 Base unit:**
 Press **[SELECT]** until the desired extension number (*H 1*, *H 2*, *H 3*, or *H 4*) is displayed on the base unit, then press and hold **[CALL]** until the CHARGE indicator flashes.
 - *H 4* can be used if you have 4 handsets.
 - After the CHARGE indicator starts flashing, the rest of the procedure must be completed within 1 minute.
- 3 Handset:**
 Press **[OK]**, then wait until the handset beeps.

Registering an additional handset

See page 6 for information on the available models and extension numbers.

Start from step 2.

Useful Information

Wall mounting

Base unit

- 1 Tuck the telephone line cord inside the wall mounting adaptor (1).
Connect the AC adaptor and telephone line cord to the base unit (2).

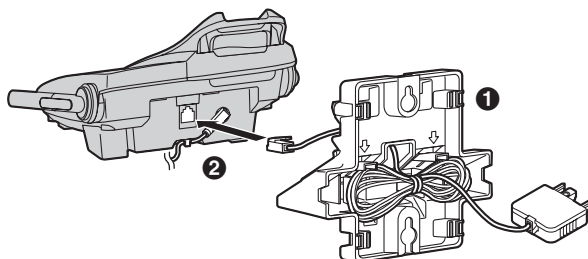

- 2 Insert the hooks on the wall mounting adaptor into the holes (A) and (B) on the base unit.

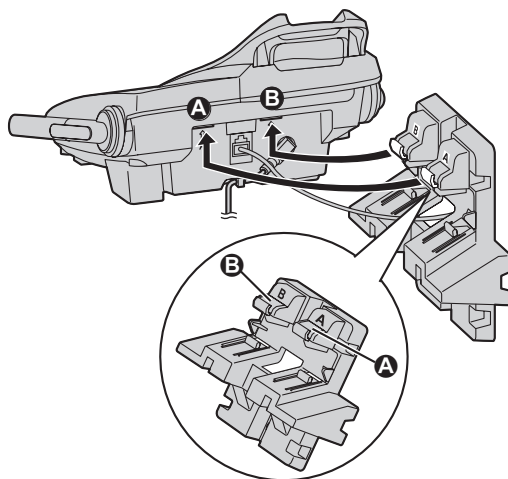

Useful Information

- 3** Adjust the adaptor to hold the base unit, then push it in the direction of the arrow until it clicks into place.

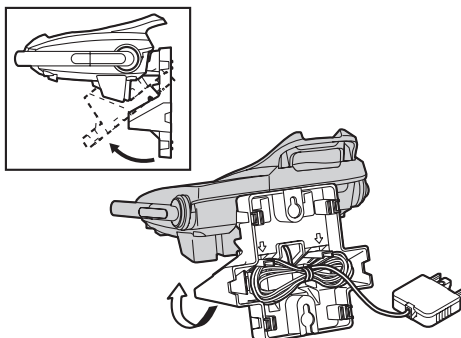

- 4** Drive the screws (not included) into the wall using the wall mount template (see below) as a guide. Mount the unit and slide it down into position. Connect the AC adaptor and telephone line cord to their respective outlets (page 13). Raise the antennas.

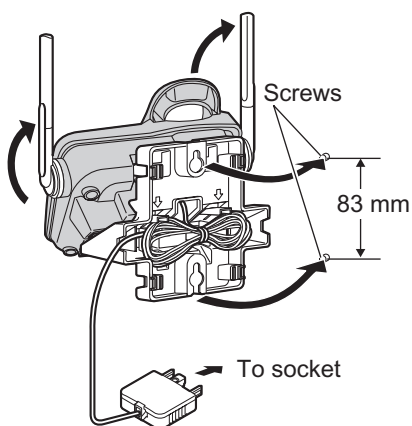

Wall mount template for the base unit

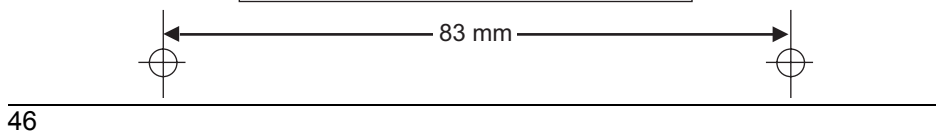

Useful Information

To remove the wall mounting adaptor

While pushing down the release levers (❶), remove the adaptor (❷).

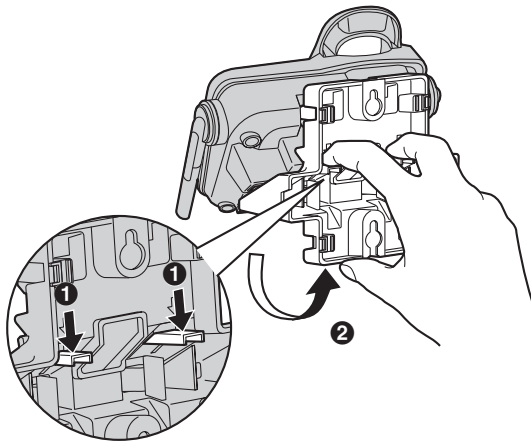

Useful Information

Charger

Available model(s):
KX-TG5932/KX-TG5933/KX-TG5934

- 1 Drive the screws (not included) into the wall using the wall mount template as a guide.

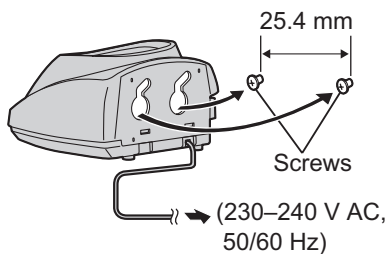

- 2 Mount the charger (1), then slide it down (2) and to the right (3) until it is secure.

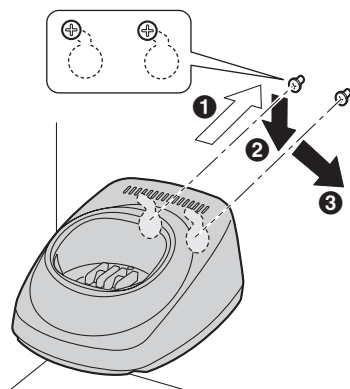

Wall mount template for the charger

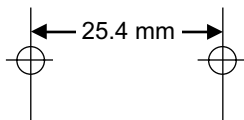

Headset (optional)

Connecting a headset to the handset allows hands-free phone conversations. We recommend using the Panasonic headset noted on page 8.



- Headset shown is KX-TCA86AL.

Note:

- Only telecommunications compliance labelled headsets should be plugged into the headset jack on the handset.

Switching a call between the headset and handset speakerphone

To switch to the handset speakerphone, press [📞].

To return to the headset, press [📞].

Useful Information

Error messages

If the unit detects a problem, one of the following messages is shown on the display.

Display message	Cause/solution
Busy	<ul style="list-style-type: none"> ● The called base unit is in use. ● Another handset or the called handset is in use.*1 ● The handset you tried to copy phonebook items to is in use.*1 ● The handset you are calling is too far from the base unit.*1
Error!!	<ul style="list-style-type: none"> ● The handset's registration has failed. Move the handset and base unit away from all electrical appliances and try again. ● Another handset user tried to send phonebook items to you but there was an error. Have the other handset user re-send the items to you (page 27).*1
---Incomplete--- Phonebook full	<ul style="list-style-type: none"> ● The destination unit's phonebook memory is full. Erase unnecessary items from the destination unit's phonebook (page 26).*1
Invalid	<ul style="list-style-type: none"> ● There is no handset registered to the base unit matching the extension number you entered.*1
No items stored	<ul style="list-style-type: none"> ● Your phonebook or redial list is empty.
No link to base. Move closer to base, try again.	<ul style="list-style-type: none"> ● The handset has lost communication with the base unit. Move closer to the base unit, and try again. ● Confirm that the base unit's AC adaptor is plugged in. ● Raise the base unit antennas. ● The handset's registration may have been cancelled. Re-register the handset (page 44).
Phonebook full	<ul style="list-style-type: none"> ● There is no space to store new items in the phonebook. Erase unnecessary items (page 26).
Please lift up and try again.	<ul style="list-style-type: none"> ● A handset button was pressed while the handset was on the base unit or charger. Lift the handset and press the button again.
System is busy. Please try again later.	<ul style="list-style-type: none"> ● Other units are in use and the system is busy. Try again later.*1 ● Another user is listening to messages. Try again later.

*1 KX-TG5932/KX-TG5933/KX-TG5934

Useful Information

Troubleshooting



General use

Problem	Cause/solution
The unit does not work.	<ul style="list-style-type: none"> • Make sure the battery is installed correctly and fully charged (page 14, 15). • Check the connections (page 13). • Unplug the base unit's AC adaptor to reset the unit. Reconnect the adaptor and try again. • The handset has not been registered to the base unit. Register the handset (page 44).
I cannot hear a dial tone.	<ul style="list-style-type: none"> • Confirm the telephone line cord is properly connected (page 13). • Disconnect the unit from the telephone line and connect a known working telephone. If the working telephone operates properly, contact our service personnel to have the unit repaired. If the working telephone does not operate properly, contact your service provider/ telephone company.

Programmable settings

Problem	Cause/solution
I cannot programme items.	<ul style="list-style-type: none"> • While another user is listening to messages or the answering system is answering a call, you cannot programme items. Try again later.
While programming, the handset starts to ring.	<ul style="list-style-type: none"> • A call is being received. Answer the call and start again after hanging up.

Battery recharge

Problem	Cause/solution
I charged the battery fully, but  continues to flash, or  is displayed.	<ul style="list-style-type: none"> • Clean the charge contacts and charge again (page 15). • The battery may need to be replaced with a new one (page 14).
The handset display is blank.	<ul style="list-style-type: none"> • Confirm that the battery is properly installed. • Fully charge the battery (page 15).

Useful Information

Making/answering calls, intercom

Problem	Cause/solution
Static is heard, sound cuts in and out. Interference from other electrical units.	<ul style="list-style-type: none"> ● Move the handset and the base unit away from other electrical appliances. ● Move closer to the base unit. ● Raise the base unit antennas. ● Turn on the clarity booster feature (page 23). ● If your unit is connected to a telephone line with ADSL service, we recommend connecting a noise filter between the base unit and the telephone line socket. Contact your ADSL provider for details.
The handset does not ring.	<ul style="list-style-type: none"> ● The ringer volume is turned off. Adjust it (page 35).
The base unit does not ring.	<ul style="list-style-type: none"> ● The ringer volume is turned off. Adjust it (page 22).
I cannot make a call.	<ul style="list-style-type: none"> ● The base unit is in use. Try again later. ● Another handset is in use. Try again later.*1 ● If the above remedies do not solve the problem, set the dialling mode. Press [MENU] [0] [5] [1] [Save] [OFF]. ● The unit is not designed to be used with rotary (pulse dialling) services.
I cannot redial by pressing [REDIAL] .	<ul style="list-style-type: none"> ● If the last number dialled was more than 48 digits long, the number will not be redialled correctly. Dial the number manually.
I cannot have a conversation using the headset.	<ul style="list-style-type: none"> ● Make sure that an optional headset is connected properly (page 48). ● If "SP-phone" is displayed on the handset, press [↶] to switch to the headset. ● We recommend using the Panasonic headset noted on page 8.
I cannot page the handset.	<ul style="list-style-type: none"> ● The called handset is too far from the base unit. ● The called handset is in use. Try again later.
I cannot page the base unit.	<ul style="list-style-type: none"> ● The base unit is in use. Try again later.

*1 KX-TG5932/KX-TG5933/KX-TG5934

Useful Information

Phonebook

Problem	Cause/solution
Copying stopped with an item displayed.* ¹	<ul style="list-style-type: none"> The destination handset may have lost communication with the base unit, or the destination unit user may have pressed [↶] or [↷]. The displayed phonebook item was not copied to the unit. Press [OFF]. Confirm that the destination unit is not in use and try again.

*1 KX-TG5932/KX-TG5933/KX-TG5934

Caller ID

Problem	Cause/solution
The handset does not display the caller's phone number.	<ul style="list-style-type: none"> You have not subscribed to Caller ID service. Contact your service provider/telephone company to subscribe. If your unit is connected to any additional telephone equipment such as a Caller ID box or cordless telephone jack, disconnect the unit from the equipment and plug the unit directly into the wall jack. If your unit is connected to a telephone line with ADSL service, we recommend connecting a noise filter between the base unit and the telephone line socket. Contact your ADSL provider for details. Other telephone equipment may be interfering with this unit. Disconnect the other equipment and try again. The caller requested not to send caller information (page 28). If a call is being transferred to you, the caller information is not displayed.*¹

*1 KX-TG5932/KX-TG5933/KX-TG5934

Answering system

Problem	Cause/solution
I cannot listen to messages from a remote location.	<ul style="list-style-type: none"> A touch tone phone is required for remote operation. Enter the remote code correctly (page 39). The answering system is off. Turn it on (page 40).

Useful Information

Problem	Cause/solution
The unit does not record new messages.	<ul style="list-style-type: none"> ● The recording time is set to “Greeting only”. Select a different setting (page 41). ● The message memory is full. Erase unnecessary messages (page 37).
I cannot operate the answering system.	<ul style="list-style-type: none"> ● Someone is operating the answering system. ● If someone is talking on a conference call, you cannot operate the answering system. Try again later.*1
The message indicator on the handset flashes.	<ul style="list-style-type: none"> ● New messages have been recorded. Listen to the new messages (page 37).

*1 KX-TG5932/KX-TG5933/KX-TG5934

Useful Information

Instructions to customer

Installation

Attached to this apparatus is an approval label. This label is evidence that it is a "Permitted Attachment" which has been authorised to be connected to your telephone service.

Conditions relating to connection and operation of this Permitted Attachment are contained in Telecommunications General By-Law 220 (5).

You are authorised to install this Permitted Attachment yourself by plugging it into the line socket of any regular telephone. You may connect it in place of your existing telephone or to any spare telephone socket installed in your premises.

To disconnect your existing telephone you must first remove its plug from the line socket. You can then insert the plug of your Permitted Attachment into the socket and use your equipment.

If the plug of your existing telephone cannot be readily removed, you will have to remove the screw securing it. To do this proceed as follows:

1. Loosen screw "A" sufficiently to remove the socket cover. (See Fig. 1.)
2. Remove screw "B" and withdraw the plug. (See Fig. 2.)
3. Replace screw "B". (See Fig. 3.) Ensure that it screws completely into the socket recess. (If the screw is too long, increase the hole depth or replace the screw with one 5 mm shorter.)
4. Replace socket cover and tighten screw "A". (See Fig. 4.)

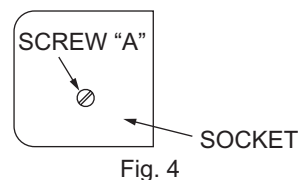
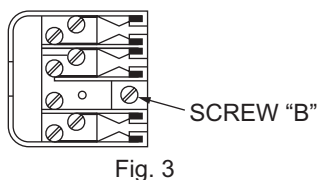
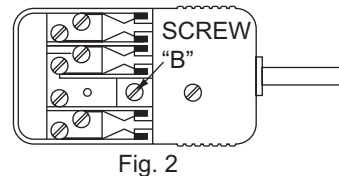
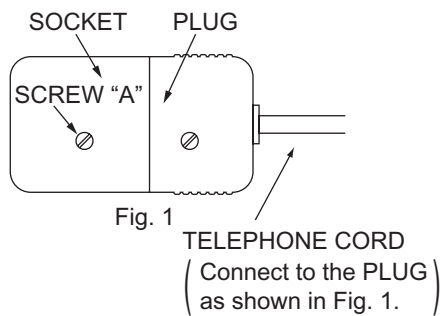

Useful Information

If you are satisfied with the operation of your telephone service after plugging in your Permitted Attachment, your installation is completed. You will be unable to connect this Permitted Attachment if your telephone service consists only of a wall phone or an old style telephone which is not connected by means of a modern plug and socket. In such cases a new socket will need to be installed. Should the Permitted Attachment not operate when plugged into a socket, it is either faulty or unsuitable for operation with your telephone service. It should be returned to the store where purchased or an Authorised Service Centre.

Service difficulties

If at any time a fault occurs on your telephone service, carry out the following checks before you call for service:

- Disconnect the Permitted Attachment and try using the service with the normal telephone.
- If the telephone service then operates satisfactorily, the fault is in your Permitted Attachment. Leave the Permitted Attachment disconnected and report the fault to its supplier or agent to arrange for repair.
- If when using the telephone the service is still faulty, report the fault to "Service Difficulties and Faults" for attention.

You are required to keep this Permitted Attachment in good working order while it is connected to your telephone service. Its construction or internal circuit must not be modified in any way without permission.

WARNING:

This cordless telephone system does not incorporate provision for secrecy of conversations. Appropriately tuned radio equipment and other cordless telephone systems in close proximity may be used by a third party to monitor and possibly interrupt conversations in progress when this system is on radio operation.

Useful Information

Specifications

General

Operating environment	5 °C – 40 °C
Frequency	5.76 GHz – 5.84 GHz

Base unit

Dimensions	Approx. height 95 mm x width 174 mm x depth 143 mm
Mass (Weight)	Approx. 320 g
Power consumption	Standby: Approx. 2.4 W Maximum: Approx. 5.6 W
Power output	200 mW (max.)
Power supply	AC adaptor (230–240 V AC, 50/60 Hz)

Handset

Dimensions	Approx. height 173 mm x width 48 mm x depth 33 mm
Mass (Weight)	Approx. 170 g
Power output	200 mW (max.)
Power supply	Ni-MH battery (3.6 V, 830 mAh)

Charger^{*1}

Dimensions	Approx. height 51 mm x width 88 mm x depth 100 mm
Mass (Weight)	Approx. 94 g
Power consumption	Standby: Approx. 1.3 W Maximum: Approx. 3.7 W
Power supply	AC adaptor (230–240 V AC, 50/60 Hz)

*1 KX-TG5932/KX-TG5933/KX-TG5934

Note:

- Design and specifications are subject to change without notice.
- The illustrations in these instructions may vary slightly from the actual product.

Index

- A** Answering calls: 22
 - Answering system
 - Erasing messages: 37, 38, 40
 - Listening to messages: 37, 38, 39
 - Turning on/off: 36, 38, 39, 40
 - Area code: 30
 - Auto talk: 22
- B** Battery
 - Charge: 15
 - Installation: 14
 - Level: 15
 - Performance: 15
 - Replacement: 14
 - Booster (Clarity booster): 23
- C** Call screening: 36
 - Call share: 23
 - Call waiting and Caller ID: 28
 - Caller ID service: 28
 - Caller list
 - Calling back: 30
 - Editing: 30
 - Erasing: 31
 - Storing: 31
 - Viewing: 30
 - Chain dial: 26
 - Conference calls: 43
 - Connections: 13, 14
- D** Date and time: 20
 - Display contrast: 34
- E** Error messages: 49
- G** Greeting message: 36
- H** Handset locator: 42
 - Headset, optional: 48
 - Hold: 22
- I** Intercom: 42
- K** Key tone: 34
- L** Light-up ID: 29
- Line mode: 35
- M** Making calls: 21
 - Memory capacity (message recording): 36
 - Message alert: 41
 - Missed calls: 28
 - Mute: 23
- N** Navigator key: 18
- P** Pause: 21
 - Phonebook: 25
 - Phonebook copy: 27
- R** Recall: 23, 35
 - Recording time: 41
 - Redial list: 21
 - Registration: 44
 - Remote code: 40
 - Remote operation: 39
 - Ring colour: 34
 - Ring count: 40
 - Ringer ID: 29
 - Ringer off: 22, 35
 - Ringer tone
 - Base unit: 35
 - Handset: 35
- S** Soft keys: 19
 - SP-phone: 21
- T** Time adjustment: 35
 - Toll saver: 40
 - Transferring calls: 43
 - Troubleshooting: 50
- V** VE (voice enhancer): 23
 - Voice guidance: 38, 39
 - Volume
 - Base unit ringer: 22
 - Handset ringer: 35
 - Receiver: 21
 - Speaker: 21
- W** Wall mounting
 - Base unit: 45
 - Charger: 48



Notes

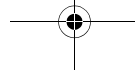
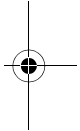
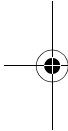



Notes

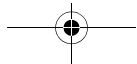

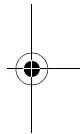
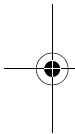
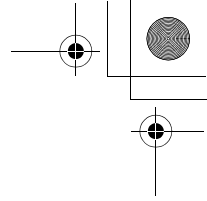
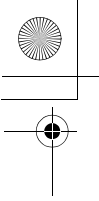

Customer Support Centre Tel. No.: 132600 or website www.panasonic.com.au

N52

Sales Department:

Panasonic Australia Pty. Limited

Austlink Corporate Park, 1 Garigal Road, Belrose NSW 2085, Australia

Manufacturer:

Panasonic Communications Co., Ltd.

1-62, 4-chome, Minoshima, Hakata-ku, Fukuoka 812-8531, Japan

Copyright:

This material is copyrighted by Panasonic Communications Co., Ltd., and may be reproduced for internal use only. All other reproduction, in whole or in part, is prohibited without the written consent of Panasonic Communications Co., Ltd.

© 2006 Panasonic Communications Co., Ltd. All Rights Reserved.

PQQX15171ZA DM0206SY1046

